

*Standard 3 or 6 meter covers and inserts are typically shipped by common carrier. Selected items can be coiled into cartons for more convenient shipping through UPS.

*Products stored in coils will have the tendency to retain a certain deformation when uncoiled, therefore consistency in the profile cross section over the full length of the coil cannot be guaranteed.

199 Piastra di trasferimento / Transfer plate / Überschubprofil

Delivery: **Easy** **Standard** Fit on 3 mm (1/8")

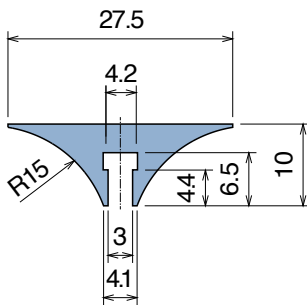
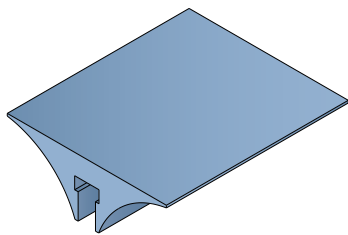

Article-Nr.	Material	Availability	Supply*
19960B	BluLub	Stock item	1,5 m bars
19960	Black	Stock item	1,5 m bars

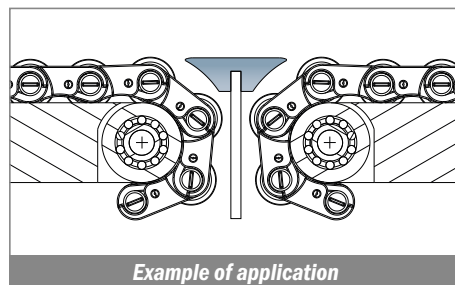

238-228-235 NoseBar / NoseBar / NoseBar

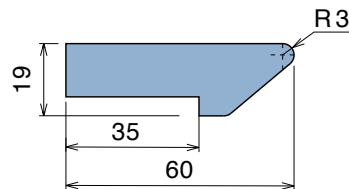
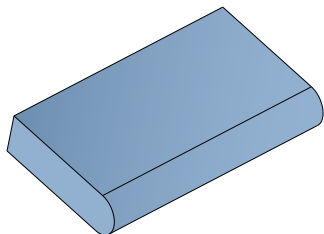

Article-Nr.	Material	Availability	Supply
2381500	BluLub	On request	1,5 m bars

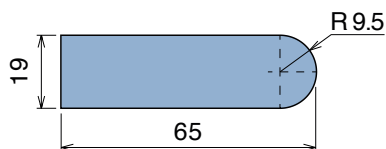

Article-Nr.	Material	Availability	Supply
2281500	BluLub	On request	1,5 m bars

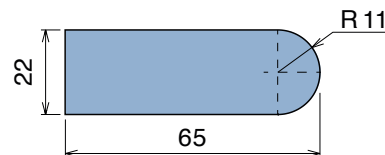

Article-Nr.	Material	Availability	Supply
2351500	BluLub	On request	1,5 m bars

NoseBars Standard



NoseBars with Bearings



NoseBars with Rollers

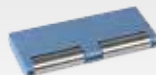

Machined to width NoseBars are available in the section Modular belts. Find more details at Page 306.

